

GWL-P1800-B Security Lock For Laptop

Slim Type

Features

- Wire lock suitable for security of laptop and TV with D terminal*. * optional adapter is needed, can also connect with GRS-232C connector port and RGB terminal
- Slim type for thin laptop
- Wire length: 1,800 mm
- Rotatable lock body and wire mounting part allow for flexible wire movement (Fig.1)
- 250 key changes available.
- Key can be removed when locked (90° rotation)
- Wire diameter $\varnothing 4$ mm

Notes

- Spring works key to pull back, push the key tightly and turn to lock and unlocked

Sold Separately

- Adapter **GPC20K**

Movement (Fig. 1)

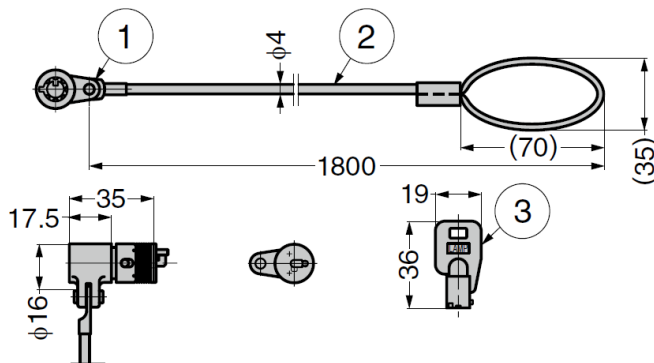
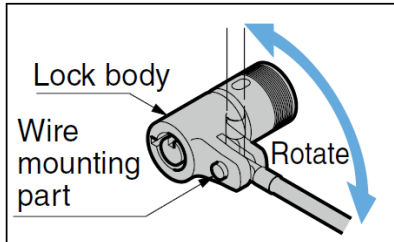

Installation

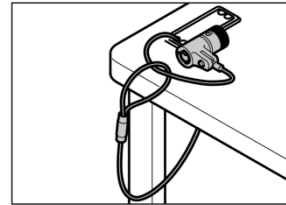

Put the wire through a hole on desk and loop

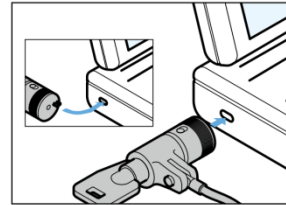

Insert the cylinder into the security hole
Please do so in unlocked position as shown on left.

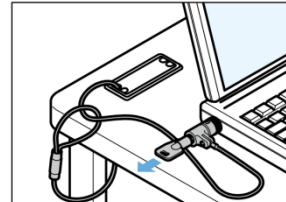

Turn the key 90° counter-clockwise to lock and remove the key
Ensure that the lock is securely locked.

Before Installation

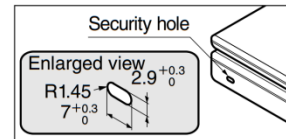

Please make sure security hole is as shown on left.

Otherwise, it cannot be installed.

No.	Part Name	Material	Finish
①	Lock Body	Zinc Alloy (ZDC)	Satin Nickel
②	Wire	Steel	PVC Coating
③	Key	Brass	Nickel

Part No.	Key Type
GWL-P1800-B	Keyed Differently

GPC20K Adapter

Features

- Adapter to connect security lock with laptop and terminals. Terminal can be connected with: RS-232C, D Terminal, RGB Terminal
- Align with one side of terminal mounting screw part on the back side of laptop or TV and fix with screw. And then secure engaging section of security lock to security hole of adapter.

Notes

- Please install so that engaging section (L-shaped part) of security lock is at the side marked with ※ as shown

Parts Included

- Pan head screw No.4-40UNC×8

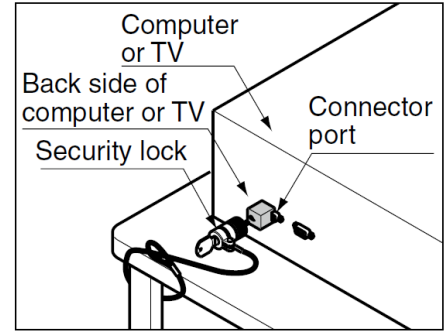

RS-232C Connector Port

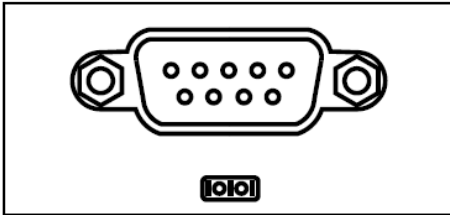

A connector attached on the back side of the computer (as shown on left), which is also known as serial connector

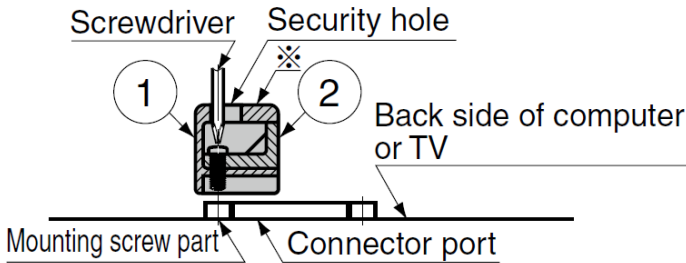
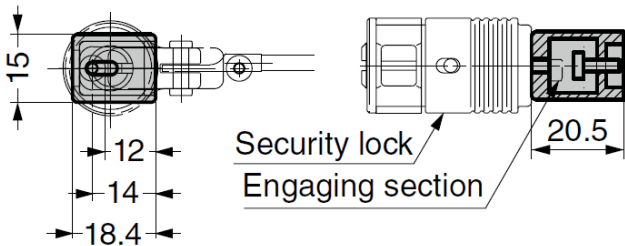

No.	Part Name	Material	Finish/Colour
①	Body	Zinc Alloy (ZDC)	Nickel
②	Cover	ABS	Black

Part No.	Material	Finish
GWL-P1800-B	Zinc Alloy (ZDC)	Nickel